



# User Manual

UpStream™ Pro Video Production Switch

---

**GUV303**

PART NO. M1617



[www.iogear.com](http://www.iogear.com)



# Table of Contents

Introduction	4
Features	5
Overview	8
Hardware Installation	12
Upstream™ Studio App & Side Menu	14
Upstream™ Studio App & Video Page	24
Upstream™ Studio App & Audio Page	31
Upstream™ Studio App & Settings Page	33
Quick Live-Stream Setup	36
Specification	41
Appendix	44
Limited Warranty	48
Contact	48
Compliance Information	49

## Introduction

The Upstream PRO™ is a portable, all-in-one, multi-channel audio/video mixer device that integrates a 1080p video capture, video switch, stream broadcaster, video converter, video splitter, and audio mixer into one compact box to eliminate the hassle of working with different AV equipment. The Upstream PRO™ broadcasts high quality live streams to CDN platforms such as YouTube Live, Facebook, and Twitch.

For added convenience, the Upstream PRO™ provides an intuitive app, making it easy to monitor, edit image layouts, and adjust PIP settings. The Upstream PRO™ is PC free, and with its well-designed control panel, makes livestreaming operations smooth and effortless. You can even preview video and monitor audio levels before going live with your broadcast! To get started, simply connect video/audio sources, an Ethernet cable, an iPad loaded with IOGear's software, and you are ready to roll.

Whether you're capturing, editing or streaming, the UpstreamPRO™, with its ergonomic, practical design, and rich feature set, it addresses the challenges that independent live streaming broadcasters encounter and provides an easy-to-use solution.

## Features

- All-in-one design to simplify streaming workflow—Integrates 1080p video capture, video switch, streaming encoder, video converter, video splitter, and audio mixer
- Professional-quality live streaming to global audiences through any CDN platform.
- PC-free and software-free with plug-n-roll capability
- Intuitive app for preview and program monitoring, video layout selections between Full Screen/PBP/PIP, adding image and subtitle overlays, and smooth scene transitions for a professional finish
- Storyboard-like management – Preset up to 8 scenes for use while streaming and during performances reducing the need to interact with hardware
- Compact mixer control panel – Switch & mix between multiple video & audio sources with the help of easily identifiable keys
- Fanless and optimized thermal air flow system for quiet operation
- Dual purpose handle and stand enhances portability and ergonomics

## Package Contents

- 1 GUV303 Upstream Pro Video Production Switch
- 1 USB Type-A to USB Type-C Cable
- 1 USB Type-A to USB Type-A Cable
- 1 AC Power Cord
- 1 Quick Start Guide

## System Requirements

- Ethernet connection (8Mbps recommended for 1080p streaming)
- The following iPad with iOS 11 or later
  - iPad Pro (1st gen, 12.9")
  - iPad Pro (1st gen, 9.7")
  - iPad Pro (2nd gen, 12.9")
  - iPad Pro (2nd gen, 10.5")
  - iPad Pro (3rd gen, 12.9")
  - iPad Pro (3rd gen, 11")

The following iPad devices with iOS 11 or later (Additional Apple Lightning to USB Camera Adapter is required):

- iPad (5th gen)
- iPad (6th gen)
- iPad (7th gen)
- iPad Air (3rd gen)
- iPad Mini (5th gen)

## Overview

### Top View

- A. iPad Stand: Allows iPad to be placed and held.
- B. HDMI 1 Audio source: Switches to the HDMI 1 audio source. The button will light up when switched to this source.
- C. PGM: Switches to the PGM audio source. The button will light up when switched to this source.
- D. Audio Level Control: Controls the volume of the selected audio source.
- E. Mute: Mutes/unmutes the audio for system that is currently tuned into. When muting source 1 or 2, AFV will also be turned off.
- F. HDMI 2 Audio source: Switches to the HDMI 2 audio source. The button will light up when switched to this source.
- G. SRC / PGM View Selector: Pressing the button will switch video source between HDMI source 1, HDMI source 2 and PGM.
- H. Pause Stream: Press this button to pause streaming.
- I. Go Live: Press this button to start streaming. Press again to stop streaming.
- J. T-Bar (transition): Slide the T-Bar to start the transition. The scene transition speed depends on how fast you slide the bar.  
Sliding the T-bar all the way to one end will complete the transition.  
You can create different effects by sliding it slowly, quickly or even hold it half way.
- K. AFV: (Audio-Follows-Video) Pressing the AFV button will light up. If the video source is selected, the source's audio will also be played.
- L. MIC: Switches to the MIC audio source. The button will light up when switched to this source.
- M. L/R: Switches to the RCA Line in audio source. The button will light up when switched to this source.
- N. Video Section (controls the video settings of the system)  
Scenes Selector: Selects the current stream (PGM) scene and the preview (PRV) scene. Button lit GREEN indicates PRV Preview. Button lit RED indicates PGM Preview.

## Overview

O. Transition Control Section (switches the current stream (PGM) scene to the preview (PRV) stream and vice versa)

Auto(transition): Pressing the Auto button will begin the transition after a specified time. (0.3-3.0 seconds)

P. Cut (transition): The transition happens immediately when you press the Cut button.

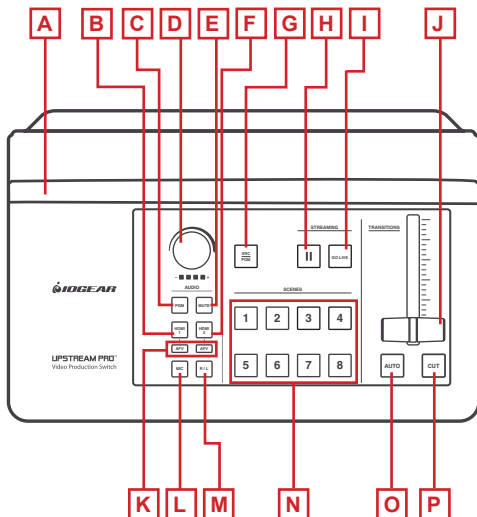

## Overview

### Rear View

- A. SRC / PGM Output Port: Program Video Output.
- B. 4K HDMI Loop out Port / 4K HDMI Input Port: An HDMI 1 input source port and an HDMI 1 Loop out.
- C. 1080P Video Input Port: HDMI 2 Input that can use Video input A or B.
- D. Ethernet Port: For internet connection
- E. USB 3.2 Gen1 Type-A Port: For firmware upgrade and USB storage for direct recording.
- F. RCA Line In Port / MIC In Port: Connect MIC or audio sources for additional audio effects.
- G. AC Power Socket: Power for the unit.

### Side View

- H. 3.5mm Audio Monitor Jack: Sound output for audio monitoring
- I. iPad Link Port (Data only): Connect to the iPad for IOGEAR Upstream™ Studio App

# Overview

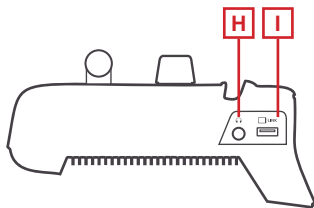
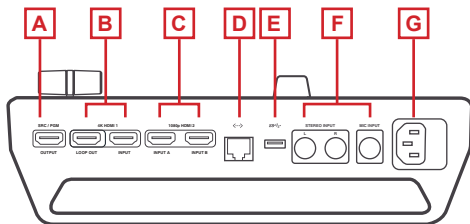

## Hardware Installation

**STEP 1.** Plug in the AC power cord and wait for the scene selection buttons to go solid

**STEP 2.** Connect the HDMI video sources

**STEP 3.** Connect the microphone and/or audio source

**STEP 4.** (Optional) Connect an HDMI display to the SRC/PGM Output port

**STEP 5.** (Optional) Connect an HDMI display to the Loop Out port

**STEP 6.** Connect an Ethernet cable for internet access

**STEP 7.** Connect your iPad to the Link Port

**Note:** :For iPad with USB-C connector, simply connect the included USB-A to USB-C cable to the GUV303 (this is a special cable).

Or use the included USB-A to USB-A cable along with an Apple Lightning USB 3 Adapter (not included) to connect to iPad devices with lightning connector.

**STEP 8.** (Optional) Connect an earphone to receive sound output for the preview

**STEP 9.** Place your iPad onto the iPad stand as shown in the diagram below.

# Hardware Installation

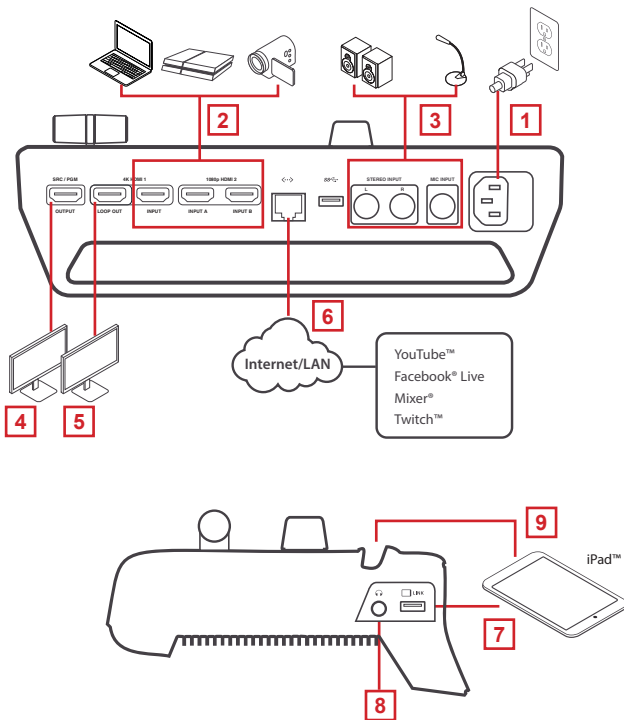

# Upstream™ Studio App & Side Menu

## Upstream™ Studio App

Upstream Studio App acts as the central controller for the GUV303. The App's design is a control panel where you can monitor program results, edit scenes, setup video and audio stream settings, and much more.

**STEP 1.** Download the IOGear Upstream Studio App from the App Store

**STEP 2.** Open the Upstream Studio app and follow the tutorial.

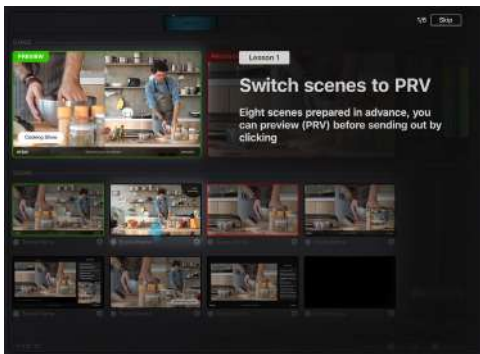

When finished, a message will be shown:

# Upstream™ Studio App & Side Menu





To run the Tutorial again, tap the  icon on the top left corner for the side menu and tap  **Tutorial**

# Upstream™ Studio App & Side Menu

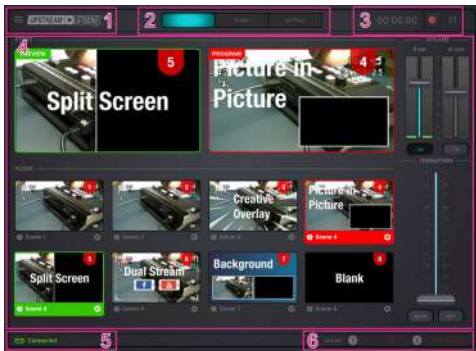
## Home page components:



1. Side Menu: Tap the  icon to bring up the side menu. Refer to Side Menu on page 17 for more details.
2. Page Selector: Tap to select the desired configuration page. Three pages are available: Video, Audio, and Settings page.
3. GoLive: Tap  to start streaming. Tap  to pause streaming. The timer on the left shows how long you have been streaming for.
4. Page Content: The content will depend on what page is open. (Video, Audio, or Settings)
5. iPad Link Status: Displays the link status between you iPad and the Upstream™ Pro
6. Network Traffic Status: Displays the network traffic status

# Upstream™ Studio App & Side Menu

## Side Menu:

A side menu is available for project management, tutorial, app information and self-diagnostic function. For the side menu, tap the  icon on the top left corner.



## Current Project

Tap the  icon to edit the name of your project: Create a Project

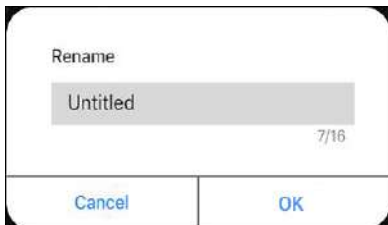

# Upstream™ Studio App & Side Menu

## Create a Project

1. Tap *Create New Project*
2. Enter a name for the project
3. (Optional) Select a template. Templates are project settings pre-configured for you. You may use these templates if you are unsure of what your project will be.
4. Tap *Create*

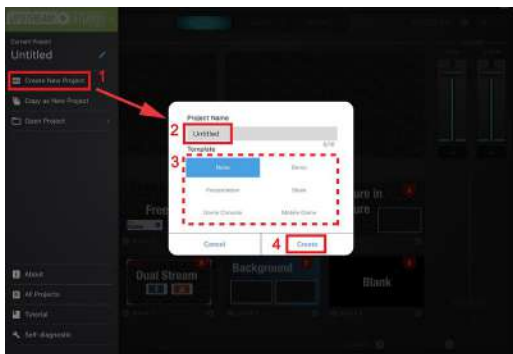

# Upstream™ Studio App & Side Menu

## Copy as New Project

If you want to use the same settings from your current project, you may use this function to copy the settings.

1. Tap *Copy as New Project*
2. Enter a name for the project
3. Tap *Create Open Project*

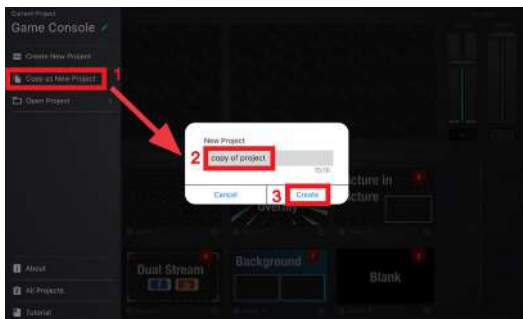

# Upstream™ Studio App & Side Menu

## Open Project

Tap *Open Project* for a list of available projects. An example is shown below



Tap to select the project you wish to use.

## About

Tap About for the information of the app. An example is shown below.



# Upstream™ Studio App & Side Menu

## All Projects

For Information of the available projects, tap All Projects. An example is shown below. You can also open or delete projects from here.

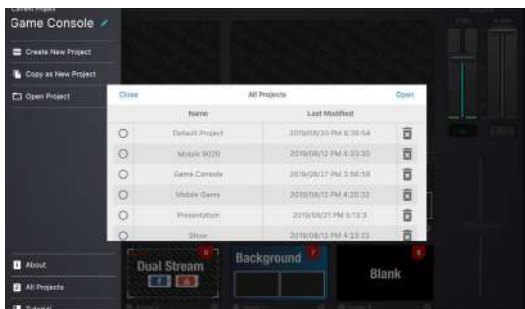

To open a project, tap to select a project and tap Open. An example is shown below.

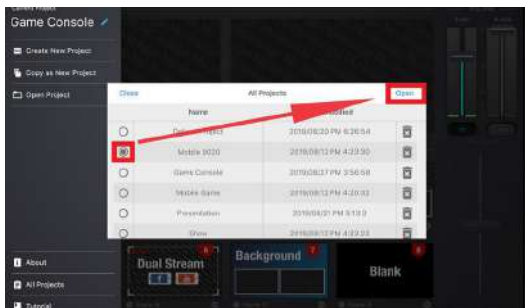

## Upstream™ Studio App & Side Menu

To delete a project, tap the garbage can icon corresponding the project. An example is shown:

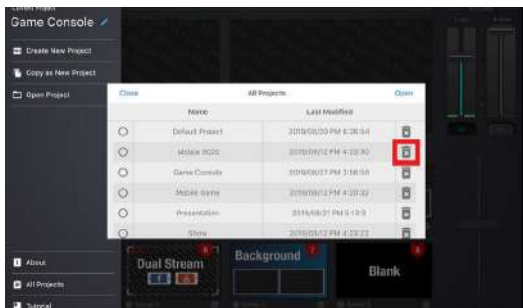

### Tutorial

Tap Tutorial to go through the tutorial again

# Upstream™ Studio App & Side Menu

## Self-Diagnostic

Tap Self-Diagnostic to generate a Diagnostic report



# Upstream™ Studio App & Video Page

## Video Page

The video page allows you to preview videos of PRV and PGM, adjust MIC and PGM volume, scene selection and editing, and transition control.



1. PRV Preview: This will show the scene which is selected in preview mode.
2. PGM Preview: This will show the program scene, or the on-air video output of the system
3. Volume Control: Tap and drag the volume slider to adjust MIC or PGM volume.

## Upstream™ Studio App & Video Page

4. Scene Selector: 8 preset scenes will be shown here.

Green outline = PRV Preview scene

Red outline = PGM Preview scene

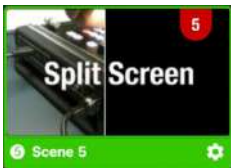

Tap a scene to select it as the PRV scene. To put the PRV scene to PGM scene, use the Transition control.

5. Scene Editor: You can configure each individual scene by tapping this icon . Refer to *Scene Editor* on page 26 on how to edit each scene
6. Transition Control: Controls the switching between the current stream (PGM) scene and the preview (PRV) stream. To switch.

1. Slide the transition bar all the way to the top or bottom; or
2. Tap the Cut button; or

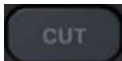

3. Tap the Auto button.

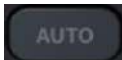

# Upstream™ Studio App & Video Page

## Scene Editor

When you tap the  icon under a scene, you can start editing the scene's display.

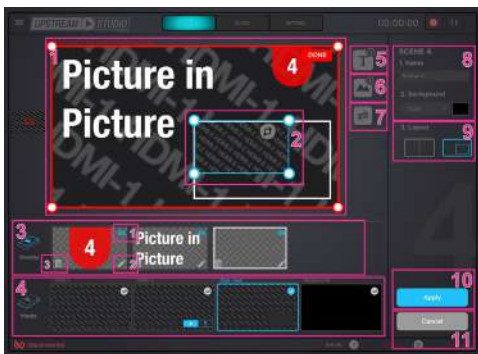

1. Scene Display: This region shows how the scene will be displayed. You can configure the components within the region
2. Resize/Crop tool: Tap to resize/crop the selected item. Refer to Resize/Crop Tool on page 28 on how to use this function.
3. Overlay: Edit imported overlays in this region. You can Delete, Edit, and Show/Hide Overlays.
  1. Show/Hide Overlay: Tap to show or hide
  2. Edit: Tap to edit
  3. Delete: Tap to delete

## Upstream™ Studio App & Video Page

- Media: Select the source(s) and how the source(s) are laid out for the scene.
  - Full Screen Mode
  - Select the source of the 1080p video input port (HDMI A or B)
  - Dual View Mode (Picture-in-Picture or Picture-by-Picture)
  - Plain Background
- Add text Overlay: Tap this icon to add a text overlay. Refer to Add/Edit Text Overlay on page 28 for more information. To edit the location and size of the overlay, select the overlay in the “Overlay” region and configure in the “Scene Display” region. The added overlay will appear in the “Overlay” region. Up to 30 text overlays (layers) are support per scene.
- Add Image Overlay: Tap this icon to add an image overlay. Tapping  allows you to add an Image Overlay. iPad will flip to the Photos page for you to select an image. Select the image and tap OK.  
To relocate, tap and hold the overlay to drag.  
To resize, refer to Resize/Crop Tool on page 28.  
The added overlay will appear in the “Overlay” region.  
Up to 5 image overlays (layers) are support per scene
- Switch Video Source (Dual-View): During dual-view mode, tapping this button switches video source position between 1 and 2.
- Scene information: This region displays the scene name and background. Tap the field to edit.
- Dual-View Layout: Tap to select the preferred dual-view (Picture in Picture or Picture-by-Picture)
- Apply: Tap this button to apply the configuration into this scene.
- Cancel: Tap this button to cancel all the configurations made in this page.

# Upstream™ Studio App & Video Page

## Resize/Crop Tool

This section describes how to resize or crop any of the components in the “Scene Display” region.

### Resize

To resize any component, tap the component (overlay or media) and a resize tool will be visible on the “Scene Display” region. Examples are shown below



Tap and hold to drag the resize tool to resize the component.

# Upstream™ Studio App & Video Page

## Crop (Media Only)

To resize a media file, tap the media file. An example is shown below:



Tap the Resize/Crop Tool to start the tool.

Pinch your finger inward or outward to crop. A small box is on the left of the “Scene Display” region to show the display area (cropped area).

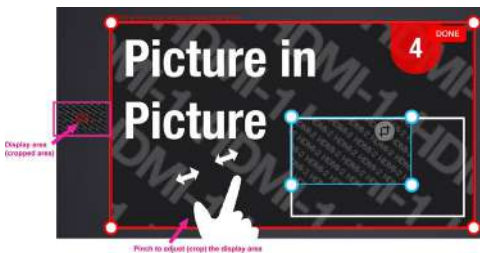

When completed, tap DONE in the top right corner.

# Upstream™ Studio App & Video Page

## Add/Edit Text Overlay

Tapping  allows you to add a Text Overlay to the scene. A pop-up configuration page will display once selected, see description below:

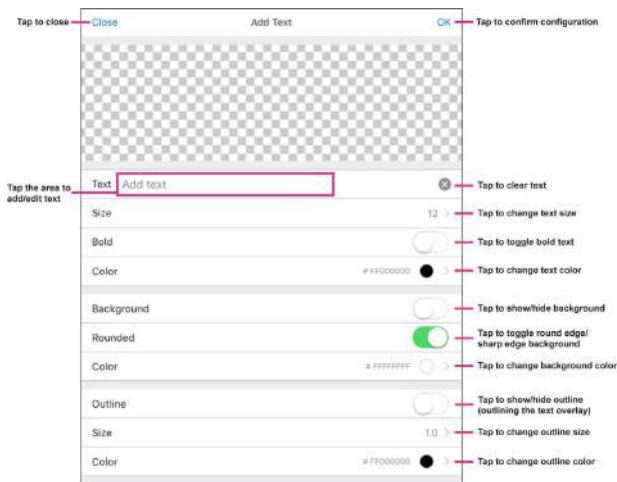

When completed, tap OK to save the configuration and return to the previous screen.

To edit the location and size of the overlay, select the overlay in the “Overlay” region and configure in the “Scene Display” region.

# Upstream™ Studio App & Audio Page

## Audio Page

The components of the Audio Mixer page are shown below.



1. Audio Level Control: Slide the volume slider to control the volume of each audio source.

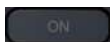

: The audio is turned off (muted)

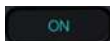

:The audio is turned on (unmuted)

Tap ON to turn on/off the sound for the source

## Upstream™ Studio App & Audio Page

### 2. HDMI 1 and 2 Audio Control:



Audio-follows-video ON: Broadcasting the source's video will also play the source's audio.

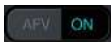

ON: The audio is turned on (unmuted)



OFF: The audio is turned off (muted)

### 3. MIC Gain Control: You can adjust the MIC Gain settings here.



Tap the fields to adjust the options

4. L/R Balance Control: Tap and hold to drag and control which side of the sound source is to be more emphasized.
5. Master/PGM Level Control: Slide the volume slider to control the volume of the Master/PGM.
6. Master/PGM Compressor: You can adjust the Master/PGM Compressor here. Tap to enable/disable the compressor function and drag the dial to adjust the threshold.



### 7. Earphone Level Control: Controls the volume level of the earphone

# Upstream™ Studio App & Settings Page

## Settings

The components of the setting deck page are shown below:



1. Stream Connection Settings: Configure livestream information here:  
Server 1 & 2:

 : Disable stream

 : Enable stream

You can stream to two platforms simultaneously if you enable both Server 1 & 2

URL and Stream Key: Obtain the URL and Stream Key from the platform(s) you wish to livestream on.

An example URL and Stream Key is shown in Example Livestream URL and Stream Key (Facebook) below.

## Upstream™ Studio App & Settings Page

Detailed configuration of your livestreaming/video recording software/platform is not within the scope of this user manual, please refer to the software/platform's instruction guide/manual.

2. Network Settings: Choose your preferred network configuration methods.  
DHCP: The network automatically assigns IP address and the corresponding fields.

Manual: If you are in a place where you are unable to utilize the DHCP method, you will need to get the settings, possibly from IT, and input them into each field here manually.

3. Stream Output Settings:

Transition Period: This is the scene transitioning delay for the Auto button (on the app or the on the unit). Choose between 0.3 and 3 seconds. (Refer to Transition Control on page 25 for the Auto button behavior)

Streaming Resolution: Select your stream resolution from one of the following.

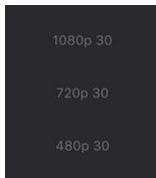

Streaming Quality: Select the quality from one of the following.

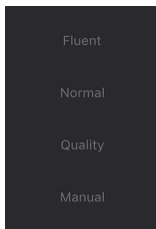

# Upstream™ Studio App & Settings Page

If manual is selected, the quality slider will light up and you can tap and drag the slider to a desired stream quality.



**Pause Picture:** Pause picture is the display when the streaming is paused. You can select black, the pause logos, or upload your own custom logo.

**Audio Delay:** If you are experiencing audio delays (due to network or other reasons), you can adjust this slider, in milliseconds, to sync the audio with the video.

4. **Reset to default:** Tap to reset the device to factory default settings

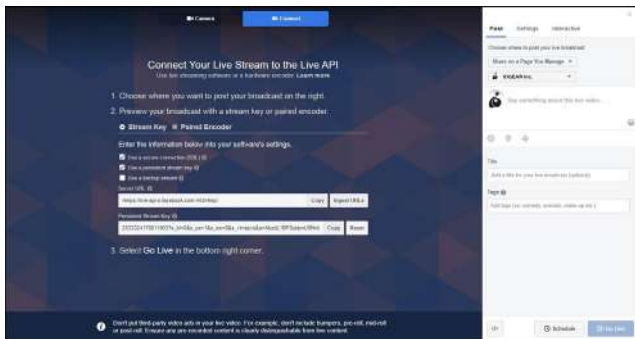

## Quick Live-Stream Setup

### Setup

Before you start live-streaming, you need to setup your live-stream platform on the GUV303.

Setting these up can be on any interface, (PC, laptop, tablets, etc.) as long as you are able to get the Server URL and Stream Key.

This section will therefore take you through obtaining the Server URL and Stream Key, inputting them into the Upstream™ Studio app, synchronizing the Upstream™ Studio app with the GUV303 and start streaming using your iPad.

Follow the steps below:

Note: Facebook is the streaming platform example used in the setup steps below.

1. On the iPad (or other device), open Safari(internet browser) and go to Facebook page.

Note: Make sure your iPad is Internet-enabled and is using desktop mode. If your iPad is always bringing you to the facebook app (or youtube, twitch, etc.), remove it from the system first and install it again later.

2. Log into your account.
3. On the dashboard, locate and tap the “What’s on your mind” field.
4. Tap and select *Live Video*

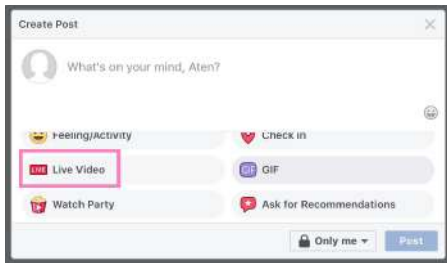

## Quick Live-Stream Setup

5. Tap the Connect button at the top of the page. A page similar to the one below is shown:

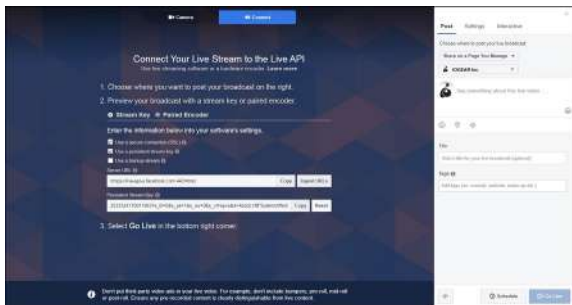

6. Server URL and Stream Key are displayed here. Copy them and enter them into their corresponding fields in the stream settings section under the “Setting” page of the Upstream™ Studio app.  
Note: It is highly recommended to check the “Use a persistent stream key” checkbox to keep this stream key.
7. Connect the iPad to your GUV303. The Upstream™ Studio app will prompt the synchronization option. Tap *Start*



## Quick Live-Stream Setup

- Configure desired settings on the Upstream Studio App and press the GO LIVE button on the unit or on the Upstream™ Studio app:



- Disconnect iPad from the unit and go to the Facebook Connect page. Upon receiving the stream, the Go Live button (on the bottom-right of the page) will light up.

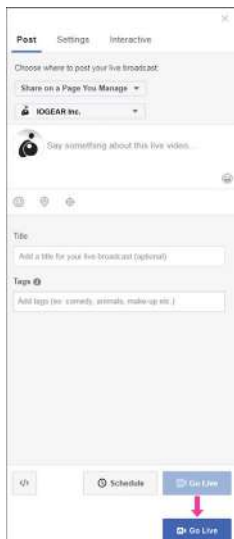

## Quick Live-Stream Setup

10. You can tap Go Live to start broadcasting your stream, or you can edit the information here (scope not part of this manual) before you start broadcasting your stream.
11. Connect your iPad to the unit to control the stream using the Upstream™ Studio App.  
Note: Streaming on other streaming platforms using the unit requires the same information (Server URL and Stream Key), refer to their websites for more information.

### During the Live-Stream

During the live-stream, you can:

- Use the transition function (T-bar, Auto button or Cut button) to switch PRV preview image to the PRG preview.



- Press the Pause button to pause streaming.



## Quick Live-Stream Setup

- Press the GO LIVE button again to stop the stream.
- Edit the video scenes in scene editor, tune audio settings in the audio mixer deck, adjusting audio delays in the settings deck, etc. Tap Apply to apply the changes.

# Specification

Video Input	1 x 4K HDMI Type A Female (up to 4K@60, no HDCP support) 2 x HDMI Type-A Female (up to 1080p@60, switcher, no HDCP support)
Video Output	1 x 4K Loop-Thru HDMI Type-A Female (up to 4K@60, no HDCP support) 1 x PGM HDMI Type-A Female (up to 1080p@60, no HDCP support)
Video Sampling	4:2:2 8-bit
Color Space	4:2:2 YUV
Video Resolution	<p><b>Input Resolution</b>  <u>HDMI1</u>  VGA: 640x480, 480p: 720x480, SVGA: 800x600, XGA: 1024x768, 720p: 1280x720,  SXGA: 1280x1024, WXGA+:1440x900, UXGA: 1600x1200 (RB), WUXGA+:1680x1050, 1080p: 1920x1080,  4K UHD: 3840x2160, 4K DCI: 4096x2160</p> <p><u>HDMI2 A/B*</u>  480p: 720x480, 720p: 1280x720, 1080p: 1920x1080, VGA: 640x480, SVGA: 800x600 XGA: 1024x768, SXGA: 1280x1024/1360x768, WXGA+:1440x900, UXGA: 1600x1200(RB)  *Only the selected port will show video. The other will show non-video photo or graph.</p> <p><b>Output Resolution</b>  <u>SRC/PGM HDMI</u>  480p: 720x480, 576p: 720x576, 720p: 1280x720, 1080p: 1920x1080</p> <p><u>HDMI Loop-Through</u>  VGA: 640x480, 480p: 720x480, SVGA: 800x600, XGA: 1024x768, 720p: 1280x720,  SXGA: 1280x1024, WXGA+:1440x900, UXGA: 1600x1200 (RB), WUXGA+:1680x1050, 1080p: 1920x1080,  4K UHD: 3840x2160, 4K DCI: 4096x2160  HDCP Support: N/A  Frame Rate: 60fps</p>

## Specification

Audio Input	HDMI captured input (stereo) 1 x Mic input, 6.5mm jack (dual mono) 1 x Line input, RCA jack
Audio Output	HDMI output (stereo) 1 x Line output, 3.5mm Jack (stereo)
Network Protocol	Multi-Publish to Streaming Server / CDN (RTMP/RTMPS) Video Encoding Format: H.264 Bit rate: 512Kbps-10Mbps Color Format: YUV420 Resolution: 1080p30, 720p30, 480p30 Audio Encoding Format: AAC Sampling Rate: 48kHz Bit rate: 128kbps
Connection	1 x USB 3.2 Gen1 Type-A Female (Blue) 1 x USB 2.0 Type-A (White) 1 x GbE LAN port
<b>Environmental</b>	
Operating Temperature	0 - 40 °C
Storage Temperature	-20 – 60 °C
Humidity	0 - 80% RH, Non-Condensing
OS Support	iPad Pro (3rd gen) with iOS 11 or later The following iPad with iOS 11 or later (Additional Apple Lightning USB 3 Adapter is required) • iPad Pro (1st gen) • iPad Pro (1st gen) • iPad Pro (2nd gen) • iPad Pro (2nd gen) • iPad (5th gen) • iPad (6th gen) • iPad Air (3rd gen) • iPad Mini (5th gen)
<b>Power</b>	
Maximum Input Power Rating	IEC 60320-1 / C14; 100-240Vac, 1A, 50-60Hz (with T1.6A/250V fuse)
Power Consumption	110V:12.9W:80 220V:12.7W:79

## Specification

Physical Properties	
Housing	Metal
Weight	1.9 kg
Dimensions (LxWxH)	28.85 x 19.00 x 9.65 cm

# Appendix

## Safety Instructions

### General

- This product is for indoor use only.
- Read all of these instructions. Save them for future reference.
- Follow all warnings and instructions marked on the device.
- Do not place the device on any unstable surface (cart, stand, table, etc.). If the device falls, serious damage will result.
- Do not use the device near water.
- Do not place the device near, or over, radiators or heat registers.
- The device cabinet is provided with slots and openings to allow for adequate ventilation. To ensure reliable operation, and to protect against overheating, these openings must never be blocked or covered.
- The device should never be placed on a soft surface (bed, sofa, rug, etc.) as this will block its ventilation openings. Likewise, the device should not be placed in a built in enclosure unless adequate ventilation has been provided.
- Never spill liquid of any kind on the device.
- Unplug the device from the wall outlet before cleaning. Do not use liquid or aerosol cleaners. Use a damp cloth for cleaning.
- The device should be operated from the type of power source indicated on the marking label. If you are not sure of the type of power available, consult your dealer or local power company.
- The device is designed for IT power distribution systems with 230V phase-to-phase voltage.
- To prevent damage to your installation it is important that all devices are properly grounded.

## Appendix

- The device is equipped with a 3-wire grounding type plug. This is a safety feature. If you are unable to insert the plug into the outlet, contact your electrician to replace your obsolete outlet. Do not attempt to defeat the purpose of the grounding-type plug. Always follow your local/national wiring codes.
- Do not allow anything to rest on the power cord or cables. Route the power cord and cables so that they cannot be stepped on or tripped over.
- If an extension cord is used with this device make sure that the total of the ampere ratings of all products used on this cord does not exceed the extension cord ampere rating. Make sure that the total of all products plugged into the wall outlet does not exceed 15 amperes.
- To help protect your system from sudden, transient increases and decreases in electrical power, use a surge suppressor, line conditioner, or uninterruptible power supply (UPS).
- Position system cables and power cables carefully; Be sure that nothing rests on any cables.
- Never push objects of any kind into or through cabinet slots. They may touch dangerous voltage points or short out parts resulting in a risk of fire or electrical shock.
- Do not attempt to service the device yourself. Refer all servicing to qualified service personnel.
- If the following conditions occur, unplug the device from the wall outlet and bring it to qualified service personnel for repair.
  - The power cord or plug has become damaged or frayed.
  - Liquid has been spilled into the device.
  - The device has been exposed to rain or water.
  - The device has been dropped, or the cabinet has been damaged.
  - The device exhibits a distinct change in performance, indicating a need for service.

## Appendix

- The device does not operate normally when the operating instructions are followed.
- Only adjust those controls that are covered in the operating instructions.
- Improper adjustment of other controls may result in damage that will require extensive work by a qualified technician to repair.
- For continued protection against risk of fire, replace only with the same type and rating of fuse - T1.6A/250V.

### Live Streaming Information

#### Create a Live Stream with Youtube

You can learn more from Youtube for “Encoder Streaming”

[https://support.google.com/youtube/answer/9227510?hl=en&ref\\_topic=9257984](https://support.google.com/youtube/answer/9227510?hl=en&ref_topic=9257984)

Or from “Set up your live streaming encoder”

<https://support.google.com/youtube/answer/2907883>

#### What is CDN Service?

A content delivery network or content distribution network (CDN) is a geographically distributed network of proxy servers and their data centers. The goal is to provide high availability and high performance by distributing the service spatially relative to end-users. CDNs serve a large portion of the Internet content today, including web objects (text, graphics and scripts), downloadable objects (media files, software, documents), applications (ecommerce, portals), live streaming media, on-demand streaming media, and social media sites.

#### RTMP/RTMPS and RTSP Protocols

GUV303 supports RTMP/RTMPS protocol but not RTSP. The Real-Time Messaging Protocol (RTMP) was initially a proprietary protocol for streaming audio, video and data over the Internet between a live stream client and

## Appendix

a server. The RTMP protocol has multiple variations. The Real Time Streaming Protocol (RTSP) is a network control protocol designed for use in entertainment and communications systems to control streaming media servers. The protocol is used for establishing and controlling media sessions between end points.

### **Other ways to input image overlays**

When your iPad is connected to the unit using direct cable link, you can upload images to the iPad directly. You can also use, and we strongly recommend you do, Apple AirDrop and its Continuity (Enable Handoff) features to upload all necessary data from Apple related products to improve convenience.

## Limited Warranty

### Warranty Information

This product carries a 2 Year Limited Warranty. For the terms and conditions of this warranty, please go to <https://www.iogear.com/support/warranty>

Register online at <https://www.iogear.com/register>

### Important Product Information

Product Model \_\_\_\_\_

Serial Number \_\_\_\_\_

## Contact

### WE'RE HERE TO HELP YOU! NEED ASSISTANCE SETTING UP THIS PRODUCT?

Make sure you:

1. Visit [www.iogear.com](http://www.iogear.com) for more product information
2. Visit [www.iogear.com/support](http://www.iogear.com/support) for live help and product support

### IOGEAR

[iogear.custhelp.com](http://iogear.custhelp.com)

[support@iogear.com](mailto:support@iogear.com)

[www.iogear.com](http://www.iogear.com)

# Compliance Information

## Federal Communication Commission Interference Statement

This equipment has been tested and found to comply with the limits for a Class B digital service, pursuant to Part 15 of the FCC rules. These limits are designed to provide reasonable protection against harmful interference in a residential installation. Any changes or modifications made to this equipment may void the user's authority to operate this equipment. This equipment generates, uses, and can radiate radio frequency energy. If not installed and used in accordance with the instructions, may cause harmful interference to radio communications. However, there is no guarantee that interference will not occur in a particular installation. If this equipment does cause harmful interference to radio or television reception, which can be determined by turning the equipment off and on, the user is encouraged to try to correct the interference by one or more of the following measures:

- Reorient or relocate the receiving antenna
- Increase the separation between the equipment and receiver
- Connect the equipment into an outlet on a circuit different from that to which the receiver is connected
- Consult the dealer or an experienced radio/TV technician for help

**FCC Caution:** Any changes or modifications not expressly approved by the party responsible for compliance could void the user's authority to operate this equipment.

This device complies with Part 15 of the FCC Rules. Operation is subject to the following two conditions:(1) this device may not cause harmful interference, and

(2) this device must accept any interference received, including interference that may cause undesired operation.

## CE Statement:

This device has been tested and found to comply with the following European Union directives: Electromagnetic Capability (2004/108/EC), Low Voltage (2006/95/EC) and R&TTED (1999/5/EC).

